

Products Introduction

P4H1



SPECIFICATION

For Intel LGA 775 Prescott	
Thermal Resistance : 0.2 °C/W	
Total dimension:114.8x114.1x87 mm	
heat sink	92x77.2x47 mm
fan	Ø95 x 25.4 mm
Fan Specification	
Speed	3600 rpm
Voltage	12V
Air Flow	63.68 CFM
Noise	44 dBA
Bearing	2 Ball
Heat Sink	
Material	Aluminum Fin
Heatpipe	Ø6 Copper Tube x 3
Weight	520 g

DRAWING

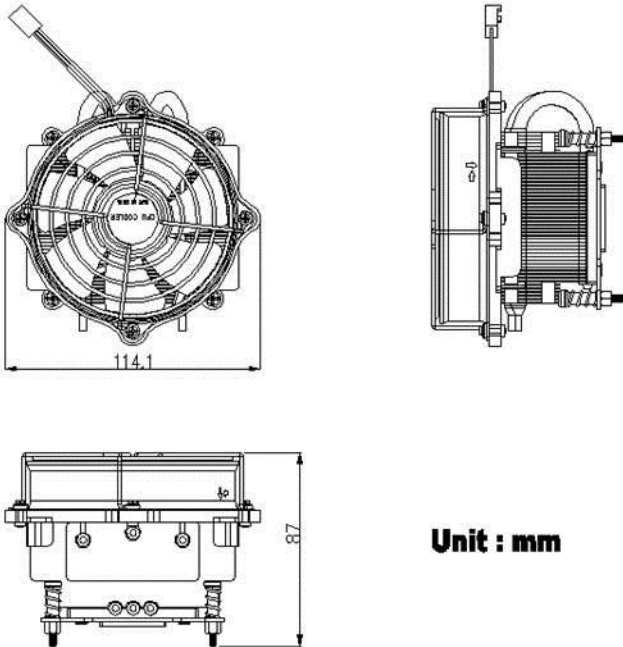

THERMAL TEST

THERMAL RESITANCE = 0.2 °C /W

Delta 9225 FAN

Ta = 45°C

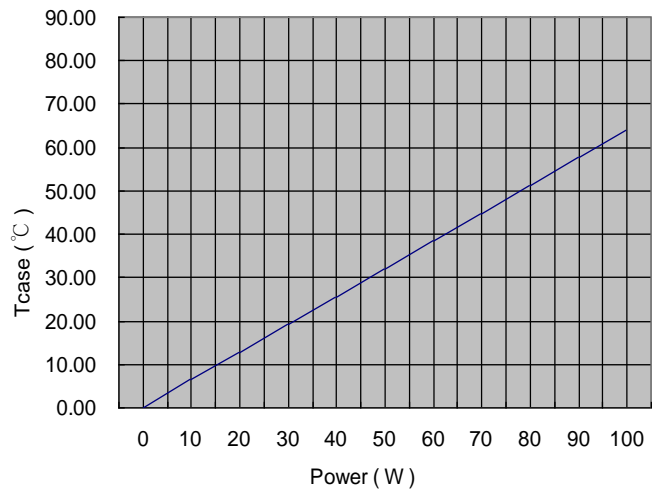

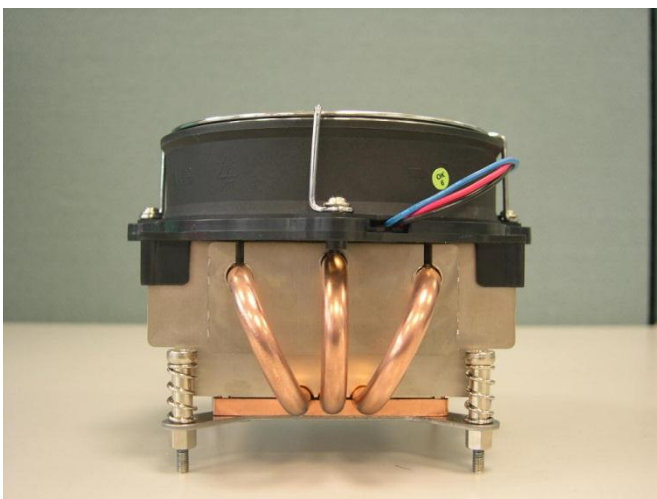
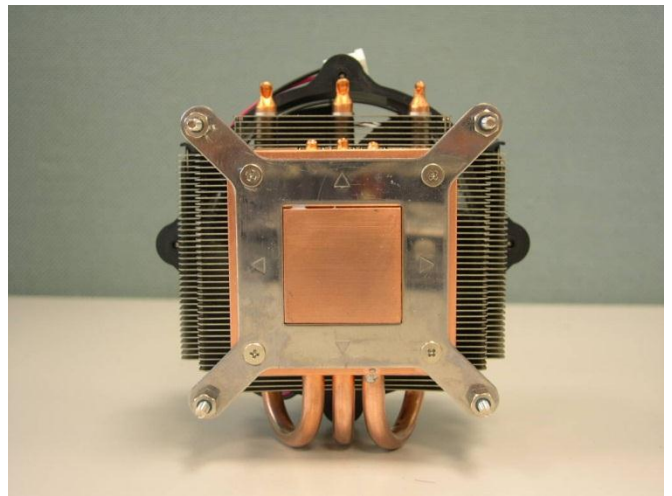
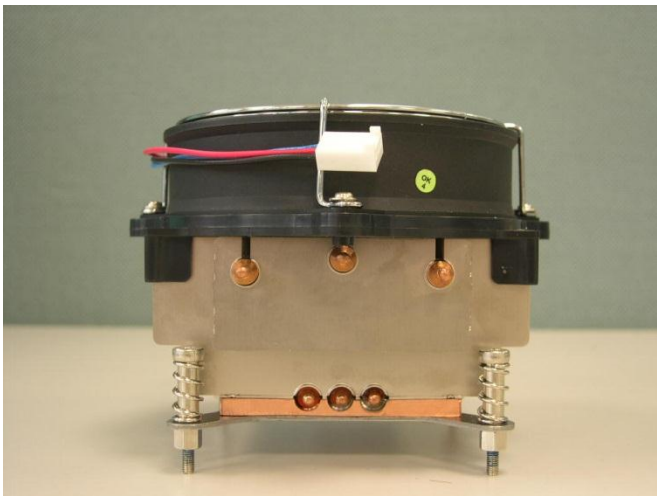
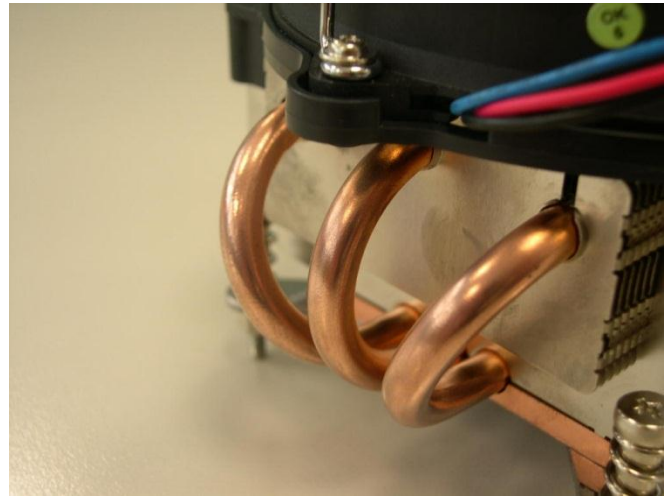
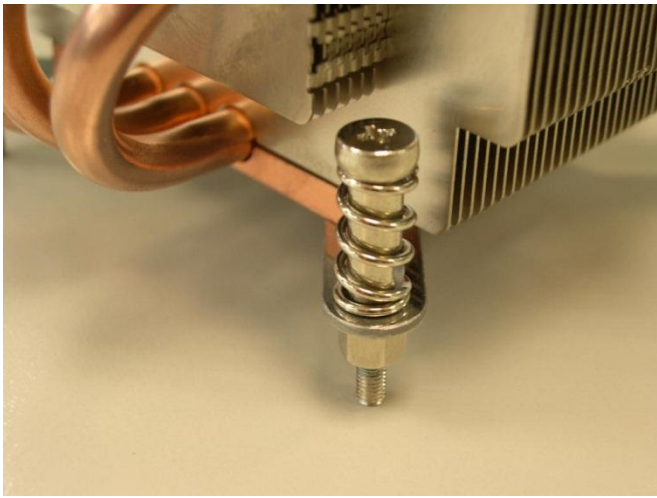

6F., No.75, Jian'an St., Xinzhuang Dist., New Taipei City 242, Taiwan (R.O.C.)

TEL: 886-2-22065314, 886-928549984

<http://www.twcooling.com>

FAX: 886-2-22065314

E-MAIL : sales@twcooling.com